

Oscillographic TV Hacking

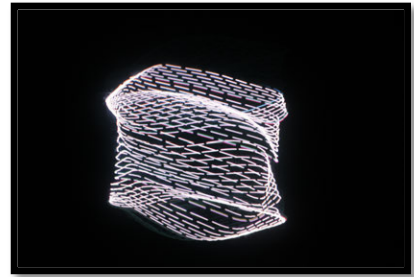
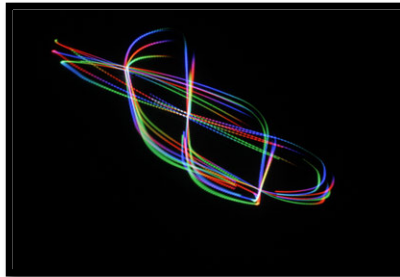
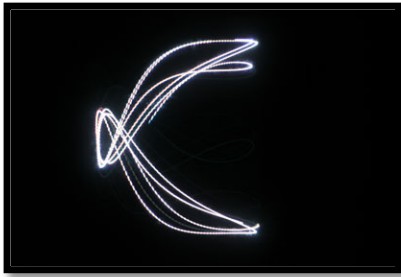

WHAT YOU NEED:

- CRT (tube style TV)
- Multi-meter or just an Ohm meter (Radio Shack)
- Wire (stranded or solid)
- Large flathead screwdriver
- Clip leads (alligator clips)
- Wire cutters
- High power “sandbar” resistors (Radio Shack)
- Electrical tape
- Wire Nuts
- Soldering iron
- Terminal mounts, RCA plugs, ¼” plugs or any other type of connector
- Stereo or audio amplifier
- Signal source (music player or tone generator)

INTRO:

This tutorial demonstrates how to hack into the deflection coil of a CRT television to create visualizations from audio sources. The process can be used as a music visualizer or a tool to sculpt *lissajous* type visuals in the style of an oscilloscope. This tutorial will cover the step-by-step process of how to modify your own CRT. You can find an example video here: <https://www.youtube.com/watch?v=my7v6ZSTBAU> and a signal generator app that can be used to design your visuals (mac only) here: [Oscillographic Generator App](#). But before we start please take note of this very serious safety reminder...

OPENING A CRT TELEVISION IS A VERY DANGEROUS PROCESS. You will be handling a device that stores **MANY** times more electricity than what comes out of the wall. Though this tutorial explains how to properly discharge a TV so it is safe to use, if you feel uncomfortable with this **DO NOT CONTINUE**. If this is your first time opening up a CRT, it can be a little frightening, but this tutorial will give you the step by step to safely working inside of one.

INSIDE THE TV:

It is good to familiarize yourself with some of the basic components of a CRT television in order to not only understand how it works, but what areas you should avoid for safety. All TVs are laid out a bit different, but they usually share many similarities in the location of these components. Here are the most essential parts for this hack:

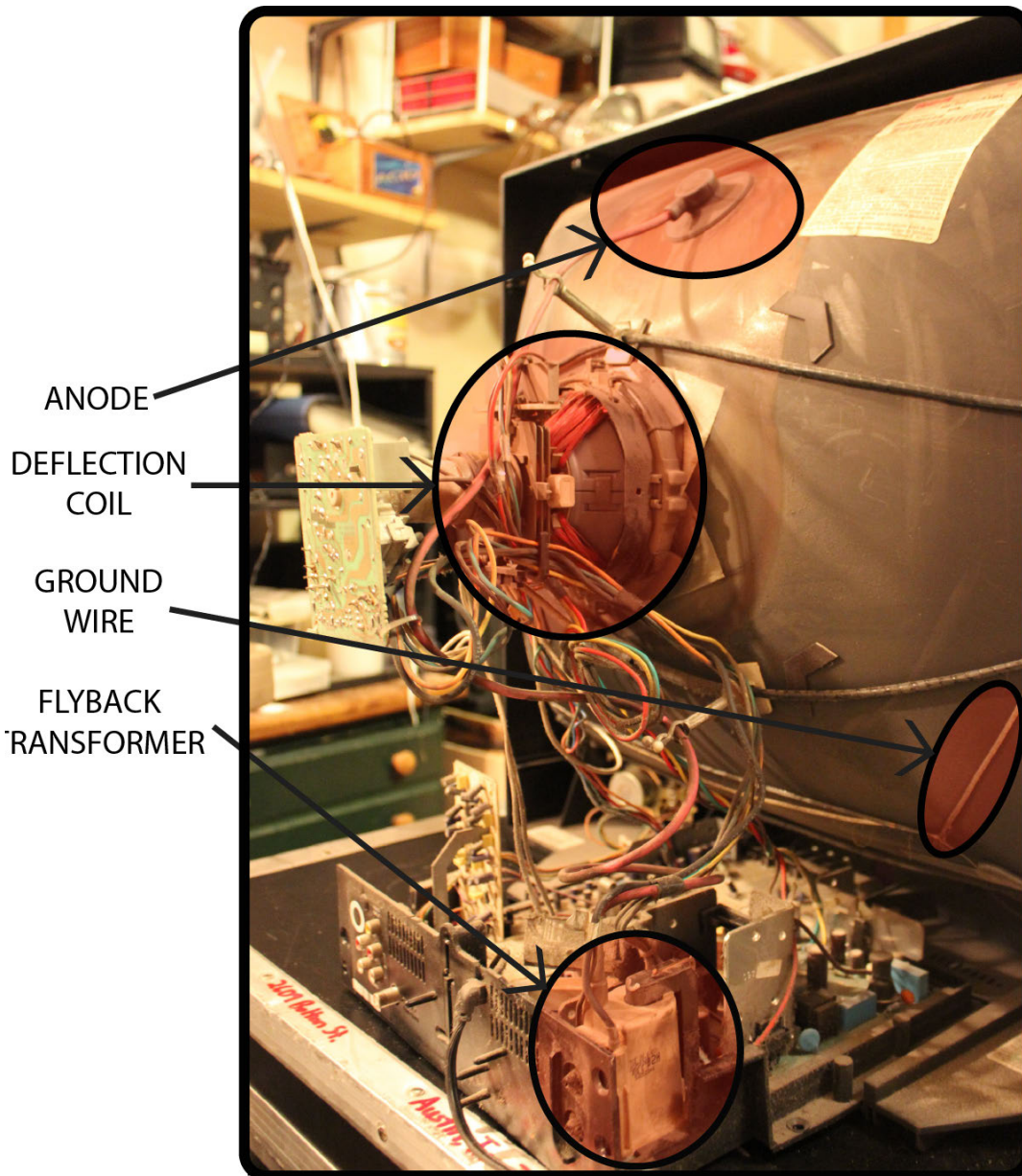

Deflection Coil: Also called the yolk, this is an electromagnet used to guide the electron beam that draws the image. It is always located in the same spot on all TVs. It looks like a very tightly wound bundle of copper wire and is connected to the back of the tube. This will be the main component of this hack.

Anode: The anode usually sits on the top of the tube and looks like a suction cup with a thick (usually red) wire coming out of it. This is a part that can carry VERY high voltages. The only time it is used is to discharge the TV, otherwise it is best to leave it alone.

Flyback Transformer: This component generates the extremely high voltages. It is attached to the thick red (usually) wire that connects to the anode. The only reason it should be pointed out is to know its location so it can be avoided. Even if the TV is discharged, it is best to leave it alone.

Ground Wire: This will most likely be an exposed wire that runs around the outside of the tube. It looks like picture hanging wire. If that is not there then, it is the metal frame surrounding the tube (Older CRTs).

FINDING THE RIGHT CRT AND OPENING IT UP

It must be a CRT (tube style) TV, no flat screens will work for this. You can find these at all thrift stores around the world for dirt-cheap. Though almost any CRT will work, it does make a difference if you use a color or B+W TV. A B+W TV will work fine if you want to stop the hacking process at the end of this tutorial, but only a color TV can be used to get the spectrum of color that can be achieved by [adding a DIY electromagnet](#) your hacked TV.

When picking out your CRT, take into account the type of hardware holding it together and make sure you have the tools to open it. Also make sure that the screws are not challenging to get to. You can open up any TV, just some are more difficult than others.

Before you open up the TV, make sure it is unplugged from the wall. Remove all the screws and set them aside. The big back part of the TV will be loose and can now slide off. Sometimes older TV's will have extra latches in the casing that you may have to use a screwdriver to detach. Be sure not to touch stuff in there until you really know what your doing. A CRT will hold a very powerful charge for a very long time. The TV is not safe to operate within until it has been properly discharged.

DISCHARGING THE CRT

****NOTE* It is important to follow basic electrical safety measures when dealing with high voltages. Where rubber sole shoes to keep yourself insulated and work on wood floors or stand on a rubber mat if available. Always keep one hand behind your back when discharging, as this will prevent the electricity from moving through your body from one hand to the other.***

For this step you will need to make a discharging tool using a big flathead screwdriver with an insulated handle (rubber or plastic) and a clip lead (alligator clip). Attach one side of the clip lead to the base of the metal of the screwdriver. The image here shows the tool I use to discharge TV's that is attached to a clip lead that has been stripped on one side and wrapped around the screwdriver and held in place with heat shrink tubing. I would suggest using some electrical tape to make sure that the clip is secured to the screwdriver.

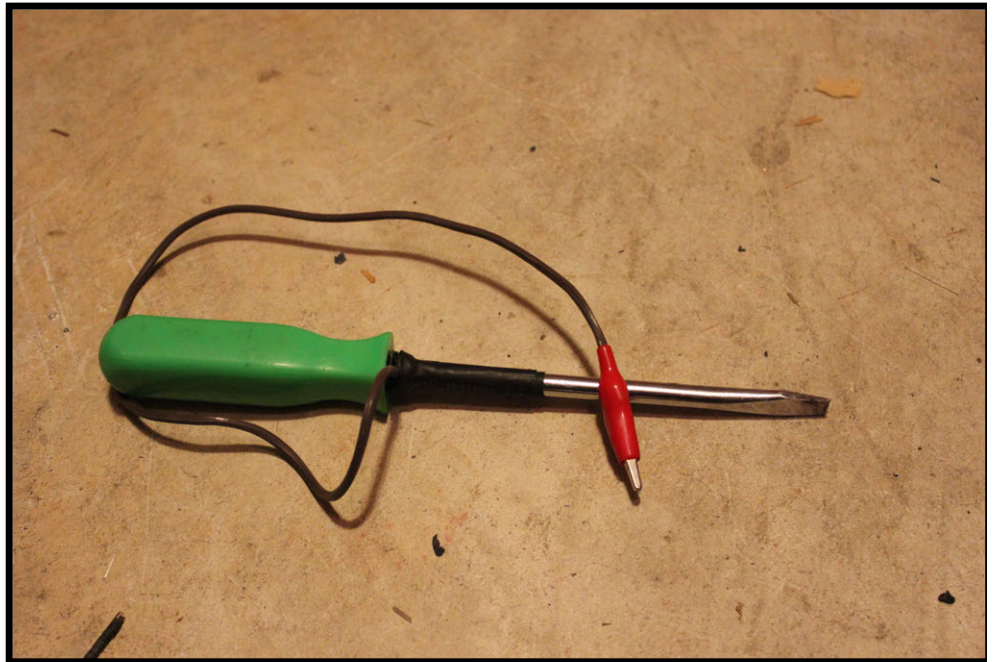

First and always, make sure the TV is not plugged in. Never work within the TV when it is powered on or connected to wall power unless you really know what you're doing. It is always safest to be completely isolated from everything before discharging, just to be safe.

Now, attach one end of the clip lead to the grounding wire or plate of the CRT (See **INSIDE THE TV** section). The image here shows the ground wire and how to attach the clip lead.

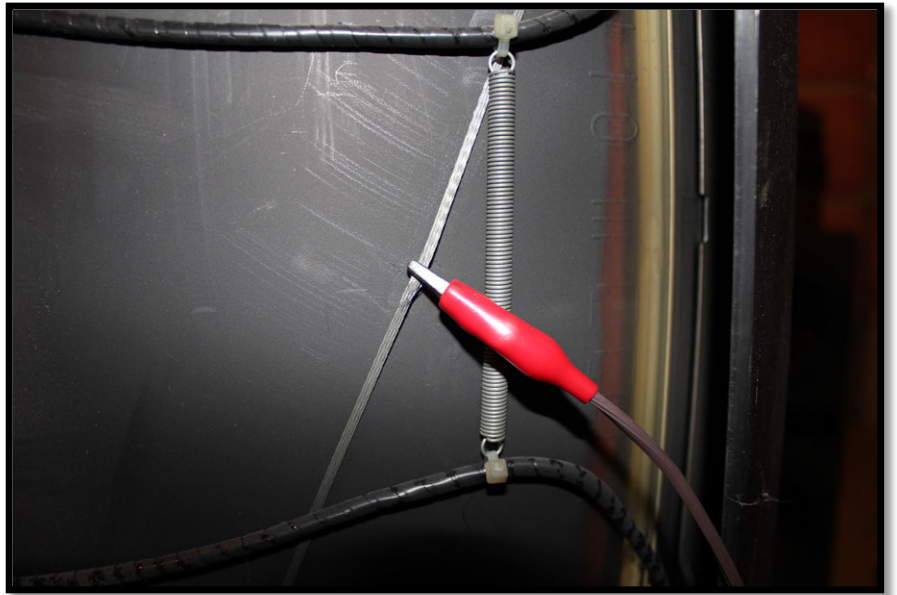

Now locate the anode (See **INSIDE THE TV** section). With one hand behind your back and while wearing your rubber sole shoes, slide the screwdriver head underneath the rubber of the suction cup. There is a piece of metal underneath the cap that you want the screwdriver to make contact with. Once it touches it, you may hear a loud snap or a quick sizzle, but don't worry because this is a good thing. That means the electricity is discharging. If you don't hear a pop, don't worry. Some CRT's don't hold as much of a charge so you may not hear it, but make sure the screwdriver is coming in contact with the metal under the rubber cap and that the clip lead is attached to the screwdriver and the ground wire.

At this point, leave the screwdriver in place for a couple minutes to ensure that all the electricity has been discharged. After that, try discharging it one more time just to be safe. Now you have a safely discharged TV to work with.

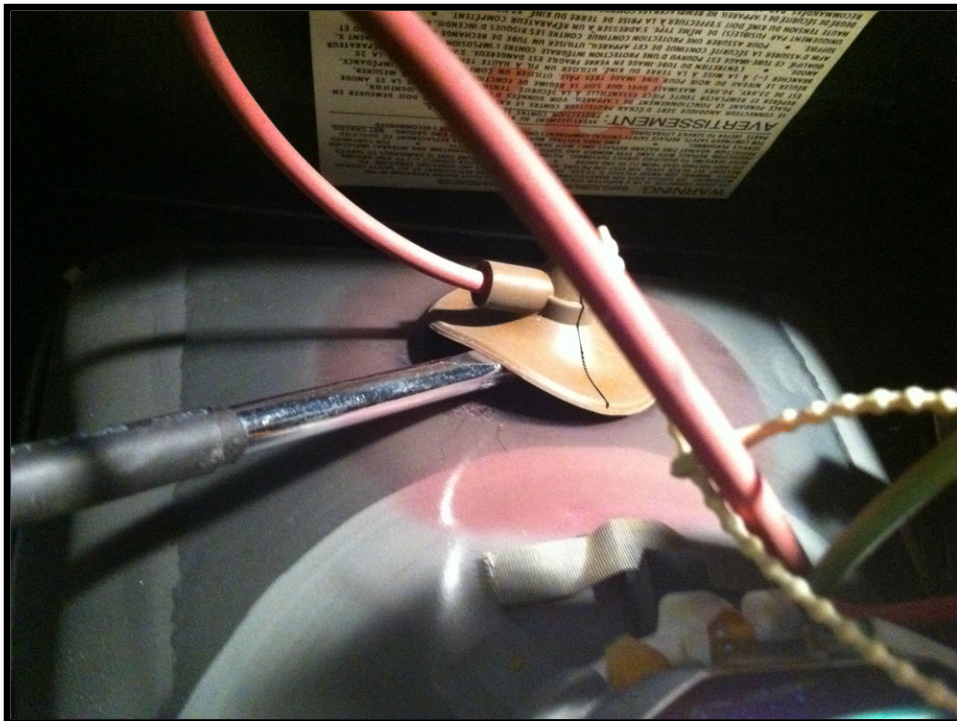

****NOTE* Even though the TV is safe to work with now, you should probably still stay away from the anode cup and the fly-back transformer. They are not used in the process and it's best to be extra safe and just leave them alone.***

THE HACK:

1. Locate and cut the deflection coil wires

The deflection coil or yoke will be the main component of this hack. It is always located at the back protrusion of the cathode tube and looks like a coil of copper wire (See INSIDE THE TV section). There are always four main wires that deliver signal to the coil, two for horizontal and two for vertical. Each direction needs two wires because the magnet requires a bi-polar signal (like and audio signal) to switch the polarity of the electromagnet from positive to negative.

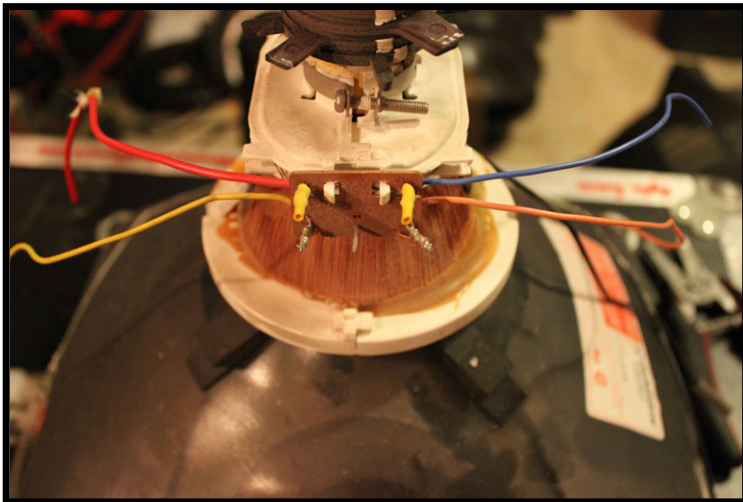
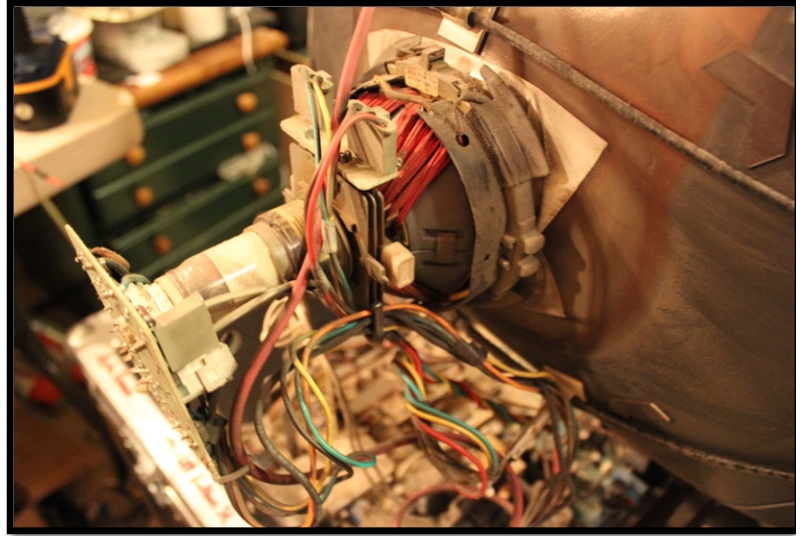

This image shows the four deflection coil wires on a removed CRT for clarity. They are always in four separate colors but each TV is different. All four wires will usually also be going to the same spot on the TV's circuit board making them easy to find. They could all be attached to the top, bottom or both the top and bottom of the coil. Once you have found them, isolate them from any of the other wires or tape that may be holding them in place, this will make them more accessible.

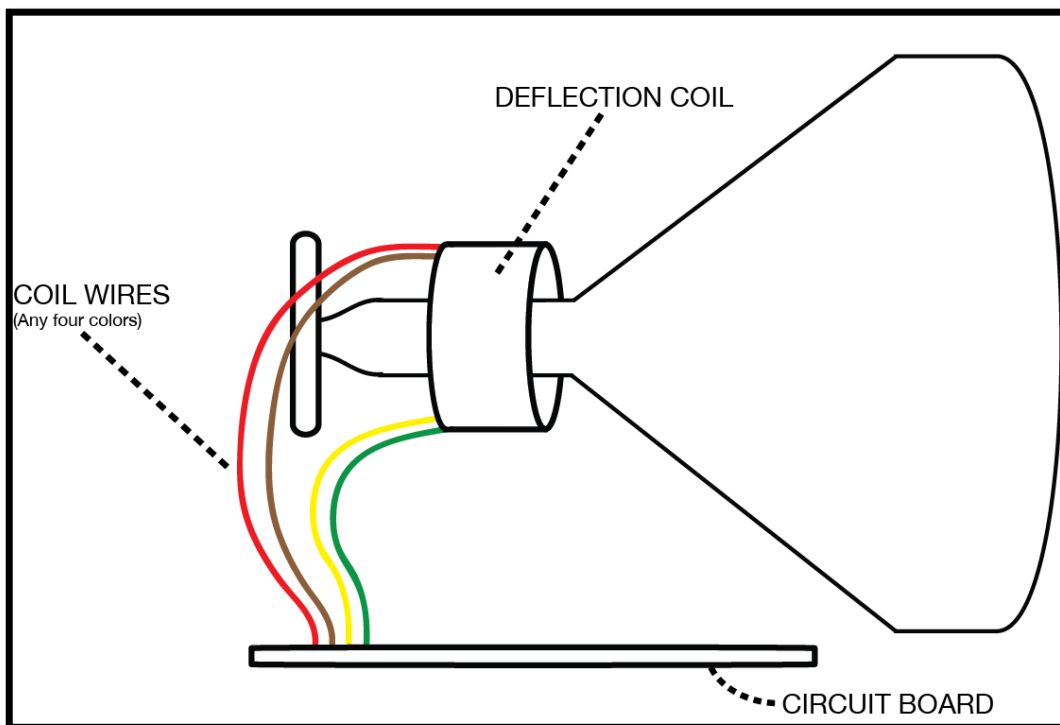

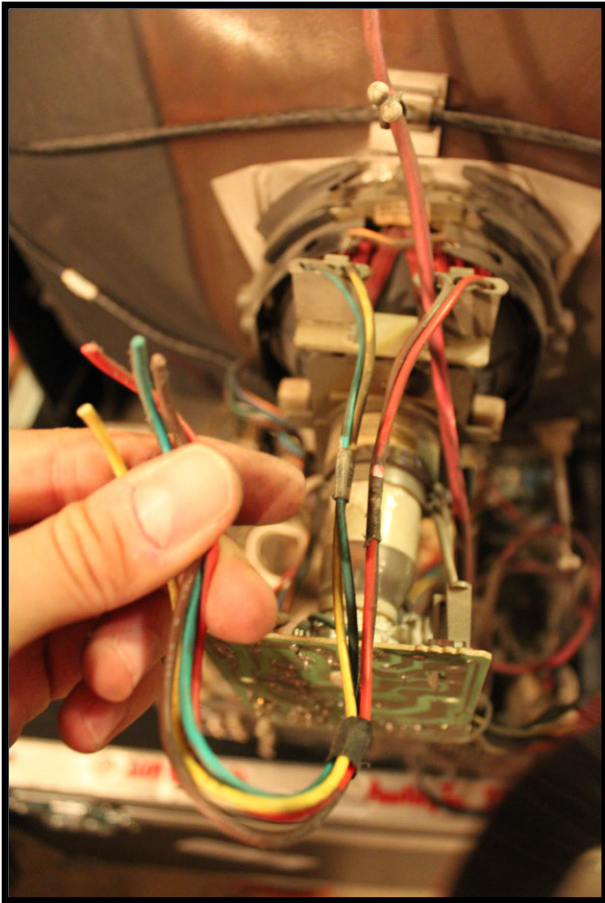

The colors for the TV being used in this tutorial happen to be red, green, brown and yellow (like in the schematic above). Once you have located the wires, cut all of them using your wire cutters. Make sure to cut them with slack for you to work on both the coil and circuit board ends. I would suggest cutting them at about their halfway point.

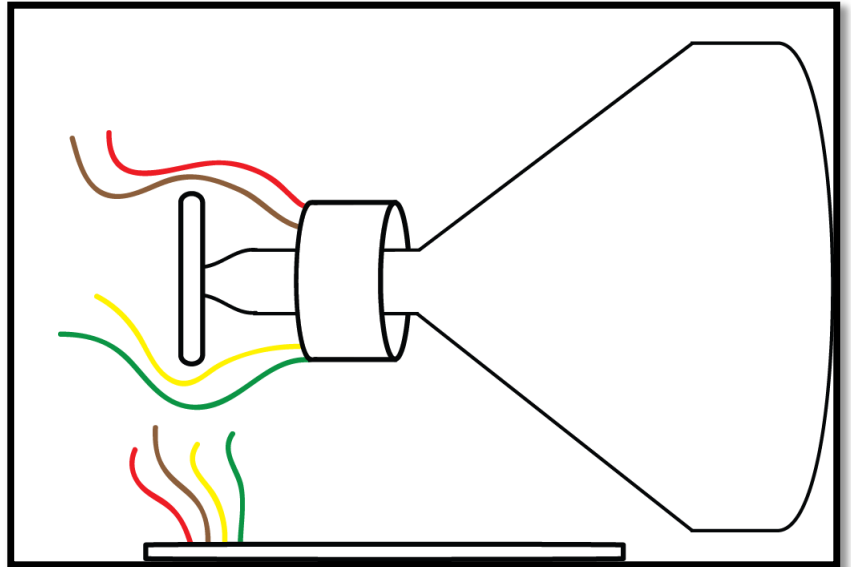

2. Measuring the impedance

Next, you will need to find which leads are connected to each other and their impedance (Impedance is similar to resistance but for alternating current). To do this you will need to use your multi-meter.

First, use your wire cutter to strip the ends of the wires connected to the deflection coil (leave the wires attached to the board alone for now; they will come into use later). Often, it is easy to see which wires are paired together from their layout, but it can also sometimes be deceiving. To be sure, we will measure the impedance using your multi-meter's resistance measurement setting. Grab any two wires and connect them to the positive and negative leads of your multi-meter (polarity doesn't matter, you will get the same readings either way). If you get an unreadable signal or it is really high, you know the two leads you are testing are not connected. Drop one of them and try another until you get a reading. **Most readings will be between approximately 1 and 20 ohms.** For the TV being used in this tutorial, I found that the red and brown wires were connected with a reading of 2 ohms, and the green and yellow wires were connected with a measurement of 6 ohms.

After you find the values, tape the wires together that are connected and write down their colors and values to remember for later. Masking tape is useful to make tags to wrap around the wires with the values written on them.

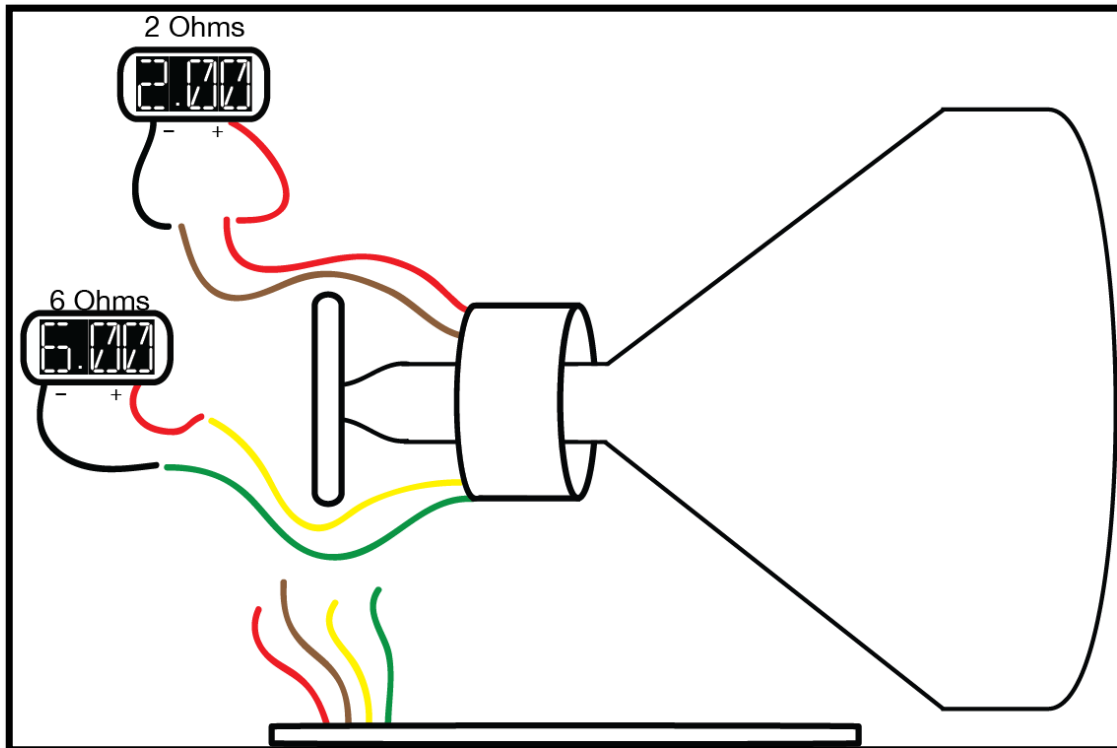
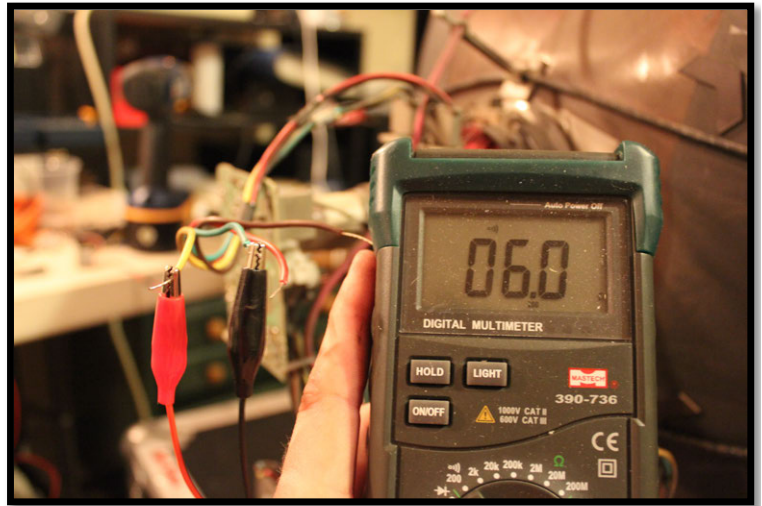
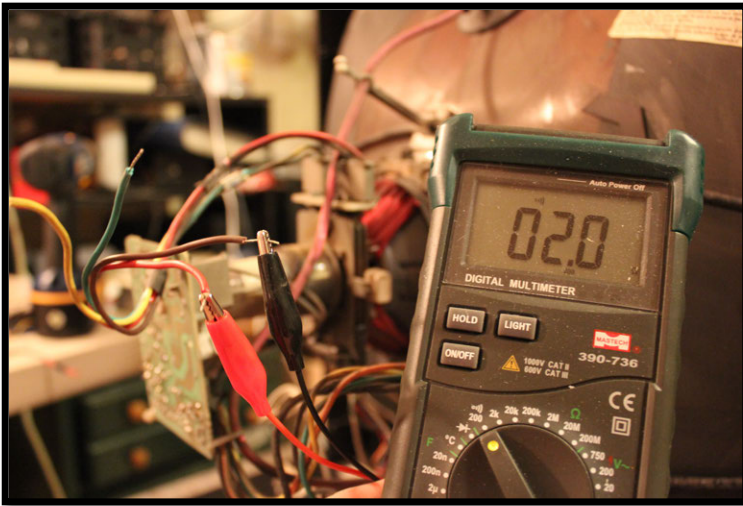

3. Making the “Dummy Coil”

Some TVs, especially newer models, are sensitive when their internal circuitry has been manipulated and can respond by not powering on, or only powering on for a few seconds. Since the wires that normally deliver a signal from the circuit board to the deflection coil have been disconnected, this can cause some problems when trying to power the TV. In order to fix this problem, you must “trick” the TV into thinking it is working properly by connecting these wires to a dummy coil made using high-powered “sandbar” resistors.

Some TV’s are more picky than others, while some may not require a dummy coil at all to operate. So be sure to test your TV without the sandbar resistors first and see if you get lucky.

A high-powered resistor, or sandbar, is a resistor that can handle high wattage applications. Fortunately for us, they are very commonly used in powered audio systems to change the impedance of a speaker setup, and can be readily found at electronics stores like Radio Shack.

Anything rated around 10 - 25 Watts should do the trick. Now is when those values you wrote down come into play.

Find some sandbar resistors with the same (or higher) ratings as the values you recorded of the deflection coil. It doesn't have to be a perfect match, just in the ballpark. Strip the four wires connected to the circuit board and attach the resistors of the appropriate sizes between the corresponding wires. For example, in the case of the example TV here, I would connect a 2 Ohm sandbar resistor between the red and brown wires, and a 6 Ohm sandbar resistor between the yellow and green wires. What this does is effectively imitate the deflection coil by using components that reflect its values. The TV doesn't know the difference and continues to operate as normal.

Use wire nuts or tape to attach the resistors for now, but make sure to cover any exposed leads with electrical tape as a short could very likely fry the TV. Don't make the connections permanent yet, there is still more testing you will need the leads for on the next step.

***NOTE* If you notice the resistors getting WAY to hot when the TV is powered on, then replace them with ones at a higher wattage rating. If your TV is larger, then it will most likely require a higher rating such as 25 - 50W, as apposed to smaller TVs that could get away with 10W.**

If you are hacking a particularly stubborn TV, there are some more tricks to keep it from shutting off. Larger value sandbar resistors may do the trick. Otherwise, try hooking up a deflection coil removed from a broken TV to the wire coming from the circuit board. If the impedance of the dummy deflection coil is close enough to the impedance of the original coil, your TV won't know the difference.

Lastly, if all else fails, you can do a "half-hack" and keep one axis of the deflection coil connected to the circuit board properly, and control the other. This should give the TV enough of what it wants to stay powered on, but you may have to experiment a bit to figure out which axis (if it's only one) is giving you the problem. With this method, you won't be able to achieve a full XY oscillographic hack, but you will be able to turn the TV into a nice oscilloscope music visualizer.

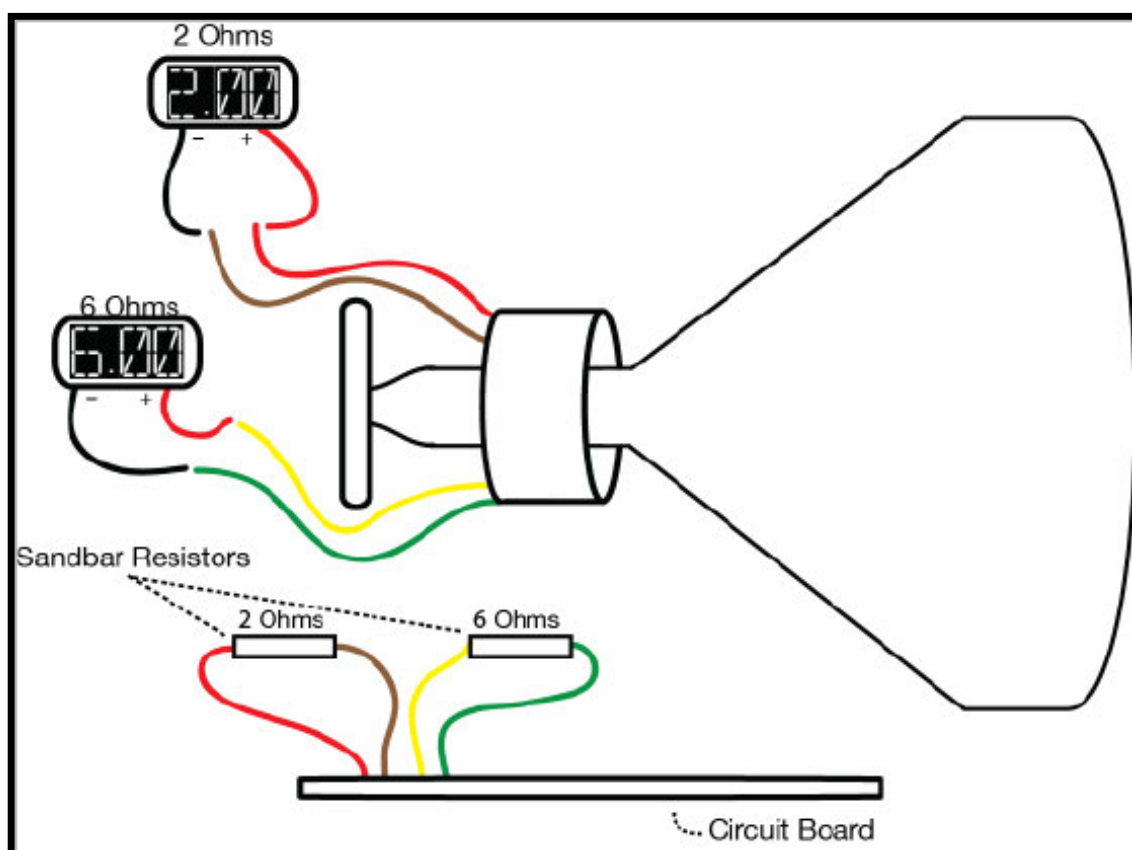

4. Finding Vertical and Horizontal

As mentioned previously, the wires going to the deflection coil control the horizontal and vertical sweep process of the electron beam (the light that makes the image). It can be very useful later on to know which wire pair controls the vertical deflection and which controls the horizontal. To find this you will need to connect one of the pairs back to the circuit board and power on the TV.

First, try powering on your TV as it is; nothing connected to the deflection coil wires, and your sandbar resistors in place. The result will be a blank screen with a very bright dot in the middle (see the image titled NO CONNECTION below). What you are seeing is the electron beam sitting at rest because the deflection coil is not guiding it in any direction. In a functioning TV, this beam is moving so quickly across the entire screen that it results in a full image. **Be sure not to touch anything inside the TV while it's powered on.**

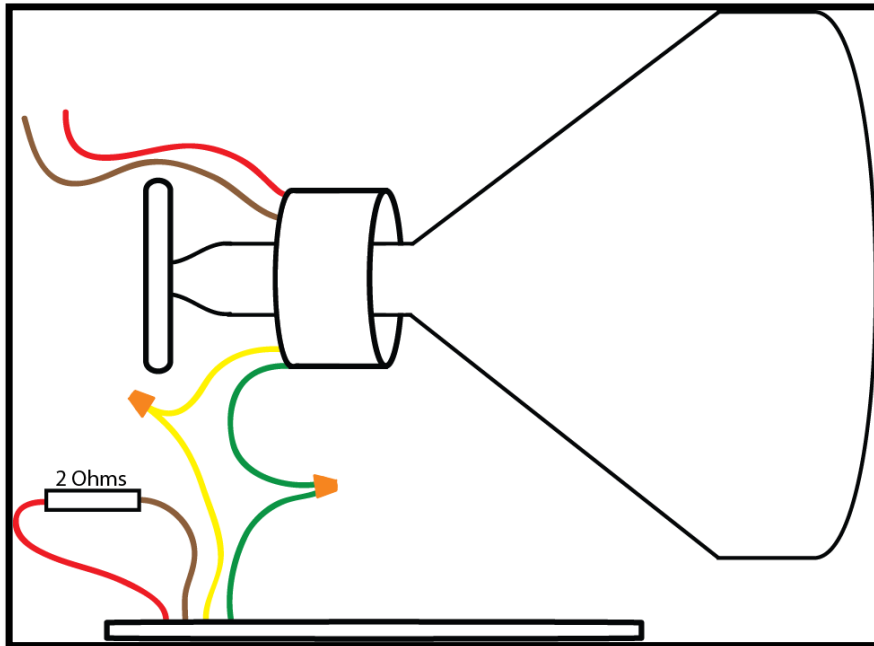

Be sure not to touch anything inside the TV while it's powered on.

Now, power down the TV, unplug it and discharge it. **Remember to discharge before every time you go back inside the TV to work.** Select one of your wire pairs (doesn't matter which), disconnect the sandbar resistor from the circuit board wires of the corresponding colors, and reconnect them accordingly using wire nuts. Only do this to one wire pair, leave the other disconnected. Again, make sure all exposed wires are covered in electrical tape or capped with a wire nut.

When you power on your TV, you will notice one of two possible results, either a horizontal line or vertical line across the screen (see images below). This will let you know if the wires that are connected control the vertical or horizontal sweep. If you are seeing a horizontal line, then you know the wires that are connected are associated with the horizontal deflection of the coil (and vice versa). At this point, you can label the wires accordingly using masking tape. It is really useful to know the orientation of the vertical and horizontal deflection for shaping your visuals later on.

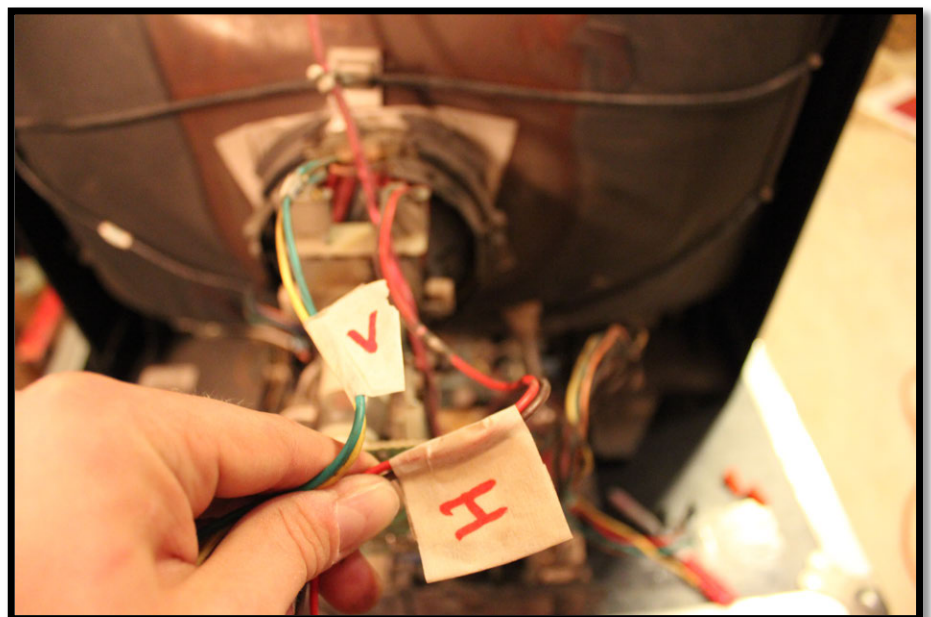

NO CONNECTION**HORIZONTAL****VERTICAL**

5. Finishing

Now that you know the orientation of the deflection coil, you can reconnect the sandbar resistor as done previously, but this time it is OK to go ahead and make the connections permanent. Either solder them in place and tape any exposed wires, or twist on some wire nuts. Find a spot inside the TV's case that you can glue the resistors to, or strap them down using zip ties. Just make sure they are clear of any parts of the TV that could cause a short. If you use hot glue, make sure it is the **high temperature** kind; the resistors can heat up and could cause the lower temperature glue to melt.

Next, you will want to make the wires of the deflection coil accessible from outside the TV once you case it back up. The best way to do this is by using some type of terminal connection like binding posts, terminal screws, speaker terminal mounts, or even RCA and 1/4" plugs. I prefer to use terminal posts (like the plugs for banana jacks) because I find them to be the most versatile. If you use binding posts or any other single pole type connector, you will require four connectors (one for each wire). But if you use bi-polar connectors like 1/4" or RCA, you will only need two connectors as each one has a ground and positive connection to utilize. Below are some example photos of a couple options.

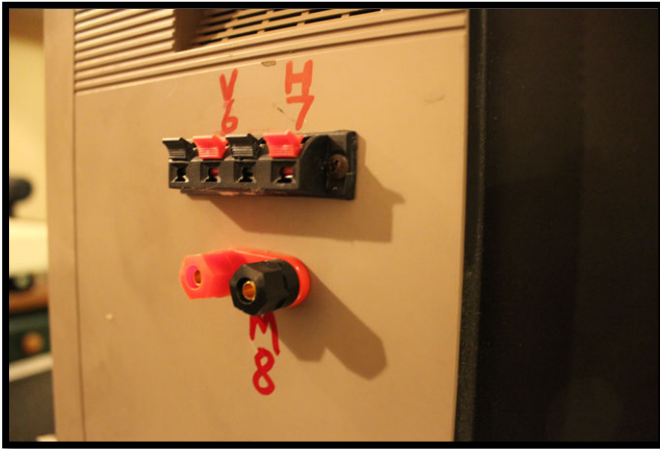

Find a spot on the outer case of your TV that has enough space to fit your terminal connectors. Make sure that the placement is away from any of the internal electronics of the TV, especially the fly back transformer. You want the connections to be completely isolated from all the internals of the TV except the deflection coil.

Cut four pieces of wire (stranded preferably but solid will also work fine) long enough to reach from the end of the deflection coil wires to the terminal connectors. Make sure you plan out a path that keeps the wires as distanced as possible from the anode, fly back transformer and the thick wire connecting them. Strip the ends of the four wires and attach them to the four

separate deflection coil wires using a soldering iron or wire nuts. Make sure to cover every bit of exposed wire with a generous amount of electrical tape.

Now, mount your terminal connectors as needed. If you use terminal posts, RCA or 1/4" plugs, use a hand drill to make the appropriately sized holes to install the hardware. If you use speaker terminal mounts (like the top section of the above left picture), you will most likely need to rout a section using a Drimmel tool or similar.

If you use 1/4" or RCA plugs, solder each wire pair from the coil to the separate jacks (one to ground and one to positive, polarity does not matter). Otherwise, for binding posts, attach each wire to the four separate connectors using the mounting hardware. Use tape or zip ties to keep the wires away from any high-powered parts of the TV. Use a marker to label to vertical and horizontal connectors on the case of the TV for reference. Once done with this, you can put the case back on the TV and you are ready to start setting up the input.

6. Hooking Up Your Hack

Now is when your stereo amplifier and signal source will come into play. Almost any audio amplifier will work for this, but I would suggest staying away from anything too hi-fi or advanced. These are more likely to have safety mechanisms that power down the device if it notices something wrong. Additionally, these types of stereos can be prone to blowing out if used improperly. You can find plenty of old stereo amplifiers at thrift stores. Also, plate and car stereo amplifiers will work as well if you know how to set one up properly. I prefer to use this amp board pictured below. It is powerful, easy to power with a wall wart, and has 4 channels. You can find it and ones like it here:

[http://www.parts-express.com/Search.aspx?keyword=amplifier board](http://www.parts-express.com/Search.aspx?keyword=amplifier+board)

There are also plenty of 2 channel options that are cheaper but just as capable.

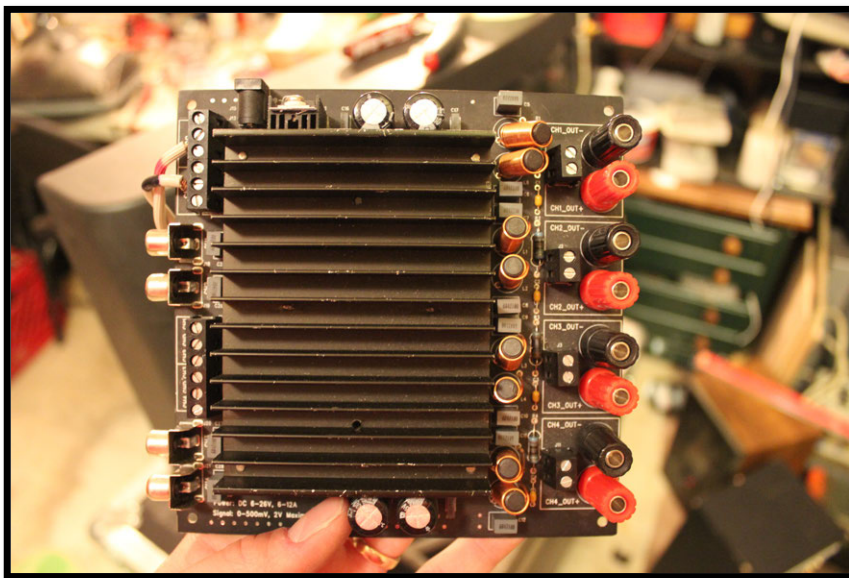

In addition to a stereo audio amplifier, you will need a signal source. Anything from an MP3 player to a function generator will work for this. Here are some things that work best...

- Custom signal generator software at [Oscillographic Generator App](#) (Mac only)
- Any other signal generator or test tone software (plenty of free ones out there. Google: "free signal generator software")
- Test tone from your DAW like Logic or Pro Tools
- Recordings of test tones or music played out of QuickTime, iTunes or an iPod
- iPhone/Android app signal generator

- Hardware function generator
- Synthesizers (software of hardware)
- Homemade synths (Ex. Nic Collins 7C14 square wave synth. Book: “Handmade Electronic Music”)

Next, use speaker wire (or any wire) to attach the speaker outputs of your amplifier or stereo receiver to the terminals on your TV. Attach the positive and negative outputs of each channel to the separate horizontal and vertical inputs (polarity doesn't matter right now) making sure that each output channel is going to a single coil input. For example, attach the left speaker output of a stereo to the two connections associated with the horizontal deflection, and do the same with the right speaker output attaching it to the vertical deflection connectors. If you are using RCA or 1/4" plugs, you may have to make your own cable to attach from the amplifier to your inputs.

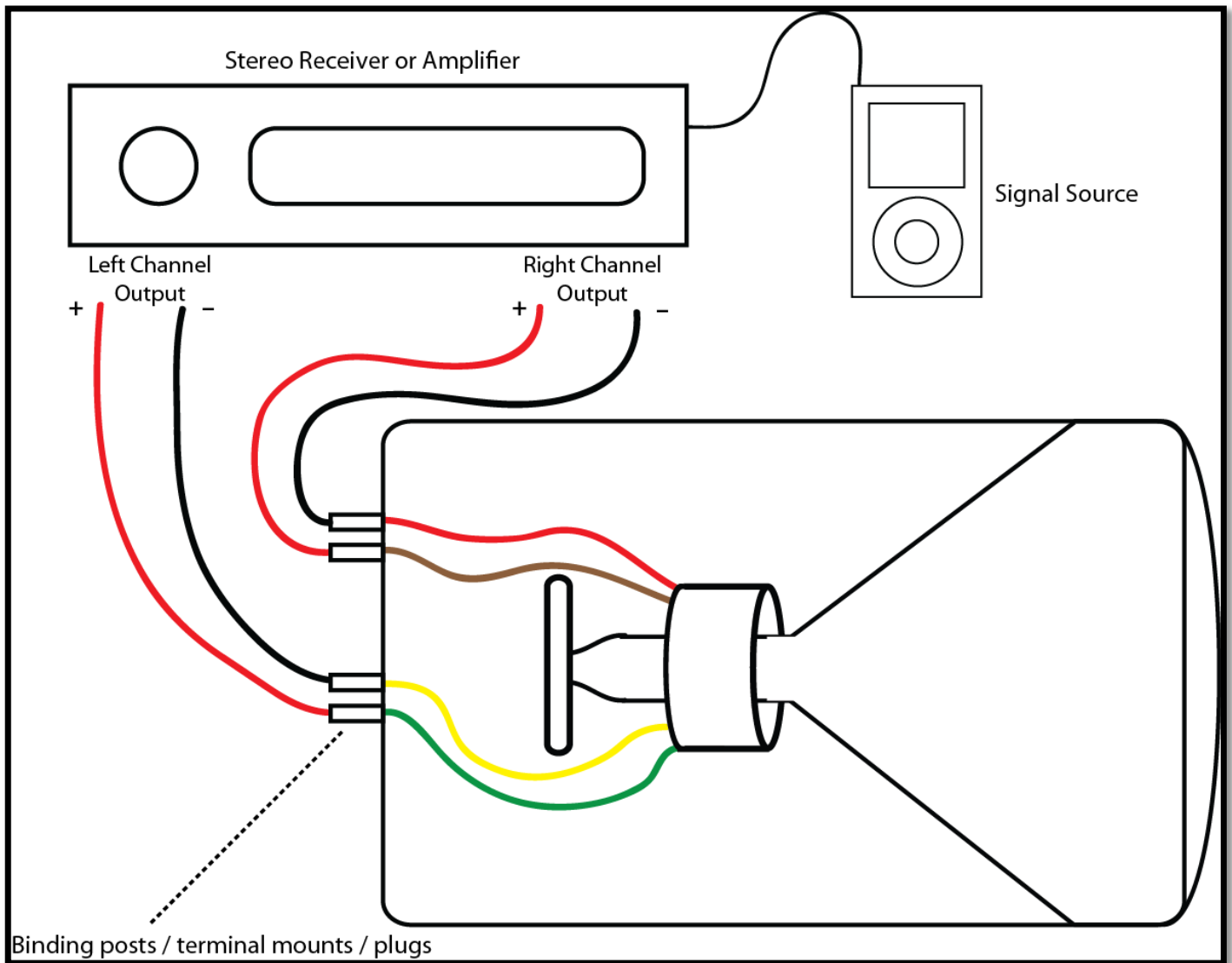

To test your hack, try starting by playing some music. Connect your iPod or computer's audio output to the input of the amplifier but keep the volume all the way down. When you power on your TV, you should see just the single dot in the center of the screen. Slowly turn up the volume of the amplifier until you start to see some movement on screen. What you will

see is a visualization of the music being played. As you keep turning up the volume, the visualization will grow larger as the coil is deflecting the beam with greater amplification. If you are seeing a full 2 dimensional image, then everything is working right, if you only see a horizontal or vertical line, open up the TV and check your connections.

To really shape your visuals takes some time and practice. Try using the software: [Oscillographic Generator App](#) (Mac only) to experiment with different possibilities. Basic waveforms, like from synthesizers or tone generators work best for making more defined visualizations and lissajous type images. Diving into Max/MSP or Pure Data can help make the images even more dramatic through FM and AM synthesis.

ADDING COLOR:

If you want to take it one step further and add colorization to the visuals, follow the same steps found in the *Building a DIY Electromagnet* and the *Hacking a Television with a DIY Electromagnet* tutorials found here: <http://crackedraytube.com/textstutorials.html> (note that this can only work with color TVs).

If you have any questions or comments, feel free to contact me at:
[yaktronix.online at gmail dot com](mailto:yaktronix.online@gmail.com)

crackedraytube.com

yaktronix.com

jameshconnolly.com

